

Part # **PLCC28**

Leads **28** Pitch **1.27mm (50mils)**

Body Size **11.5mm (.45" SQ)**

Dwg **PLCC28.pdf**

TopLineTM

Tel 1-714-898-3830

info@topline.to

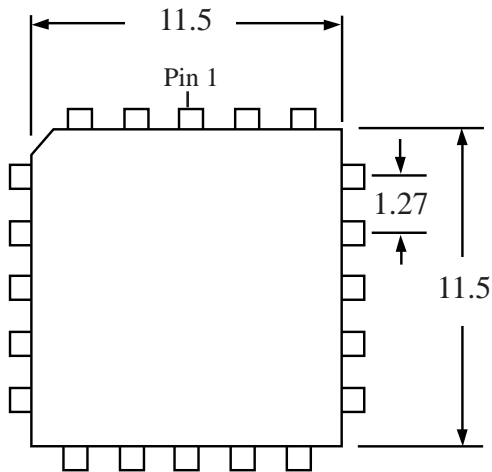

Top View

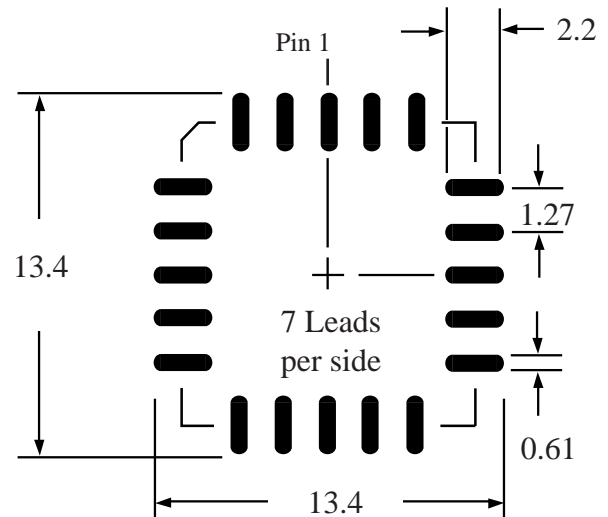

PC Board

Dimensions = mm

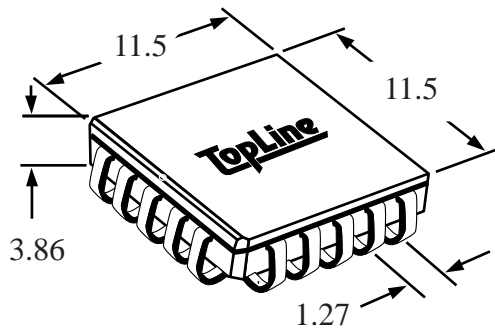

Quick View

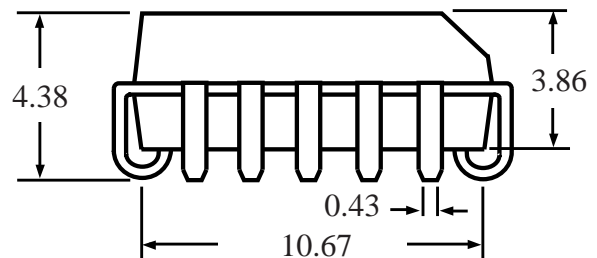

Side View Detail